

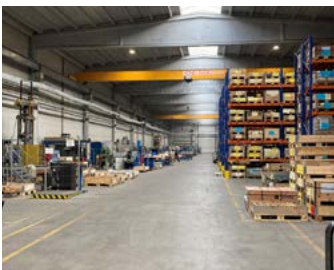

# COMPANY BROCHURE

## CONSTRUCTION AND PRECAST ACCESSORIES





## ABOUT US

**T**erwa is a company with more than 25 years of experience in the production of metal components for construction and precast industry. Terwa deploys the latest technology and has developed long-term partnerships with companies throughout the world.

Every year, our global factories in Romania, the Netherlands and China deliver large volumes of Terwa products to our customers around the globe. Terwa's modular structure allows it to constantly adapt to growing market trends. Terwa has outstripped its competition thanks to a flexible way of working and customized products that take full account of our partners' needs, and the best price-performance ratio.

Terwa is a quality producer. The company is certified according to ISO 9001:2015, 3834-2 and 14001. Our products are certified and approved according to European and global norms and standards. The quality of our products is constantly monitored throughout the entire production process and also by international specialist laboratories.

Terwa oversees the entire process of manufacturing a product, from the concept and the design right throughout to after-sales service. This allows us to adapt to any requirements and satisfy our customers' needs. The most important tasks of the design and development departments include creating new products and improving existing products, matching themselves to the demands of the construction and precast industry with the latest technical challenges adopted with innovative solutions.

The collaboration with our partners is based on trust and a long-term relationship.



# CONTENTS

<b>Service</b>	
- Software	04
- BIM support	05
- Development	06
- Quality & certifications	08
- Production	10
<hr/>	
<b>References</b>	
- Project references of Terwa	12
<hr/>	
<b>Lifting systems</b>	
- 1D heavy-duty threaded anchor lifting system	16
- 1D threaded anchor lifting system	18
- 2D strip anchor lifting system	20
- 3D T-slot anchor lifting system	22
<hr/>	
<b>Fixing systems</b>	
- Fixing inserts	24
- Anchor rails	26
<hr/>	
<b>Reinforcement systems</b>	
- Rebar connection system	28
- Mechanical splices onsite threading and coupler systems	30
- ALC alligator couplers	32
- TSB terwa starter boxes	34
- Punching and shear reinforcement system	36
- Grout coupler	38
<hr/>	
<b>Precast concrete systems</b>	
- Sandwich panel systems	40
- Terwa Precast Connector	42
- Loop boxes	44
- Column centralizers	45
<hr/>	
<b>Fastening products</b>	
- Fastening plates	46
<hr/>	
<b>Special construction products</b>	
- Balcony column fence solution	48
- Panel fixing solution	49
<hr/>	
<b>Contact details</b>	
- Contact details	51



# BIM SUPPORT



## Login

Don't have an account? [Register your company here](#)

E-mail address

Password

[Forgot password?](#) [Login](#)





# DEVELOPMENT

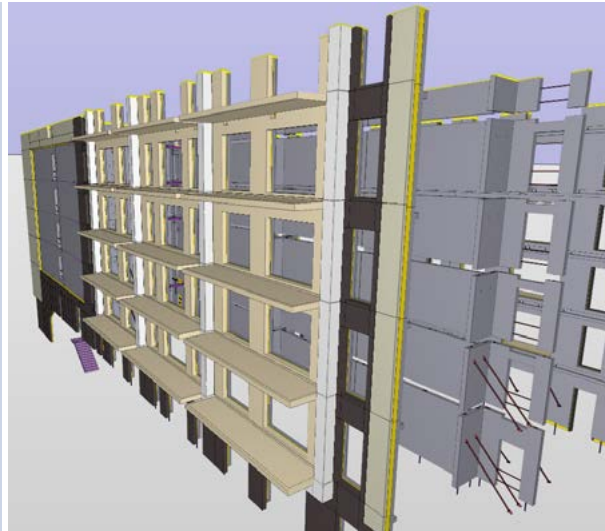
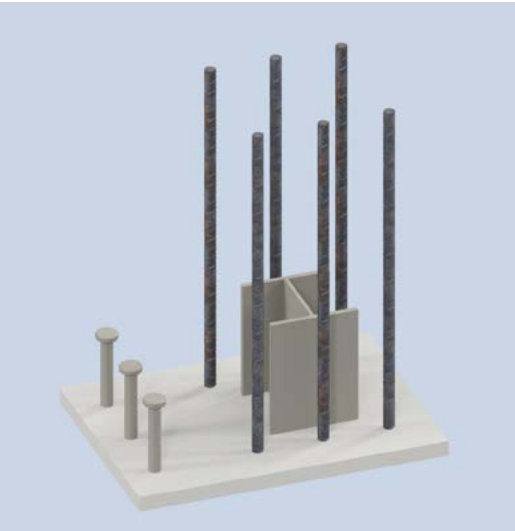
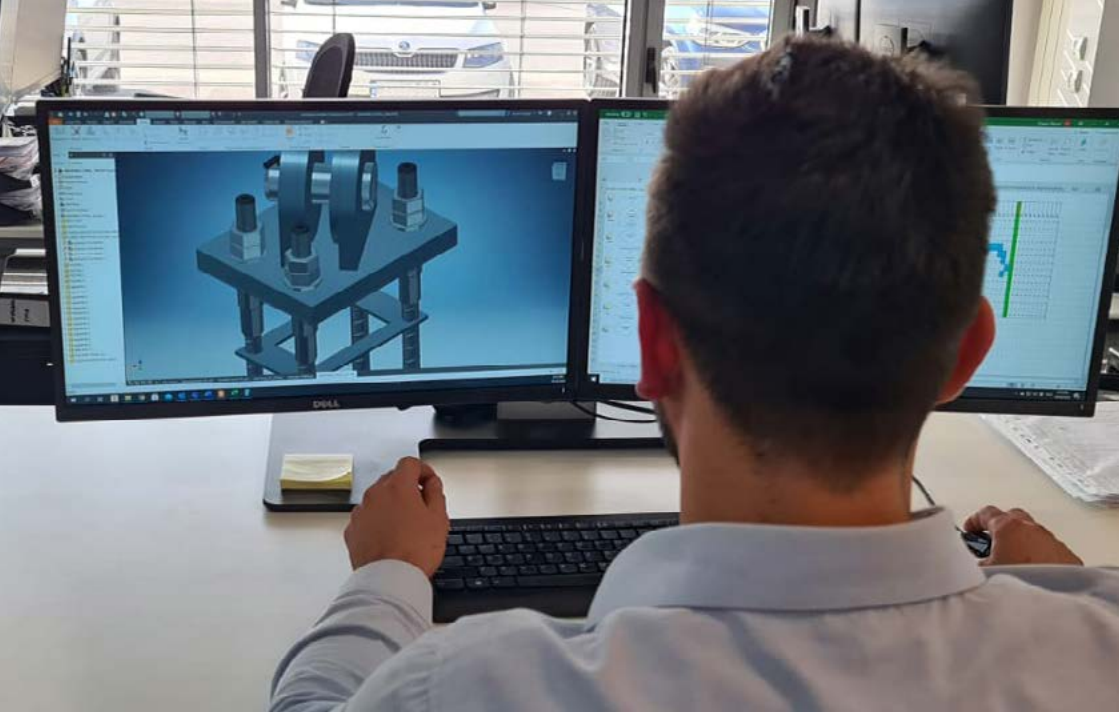

**Terwa oversees the entire process of manufacturing a product, from the concept and the design right throughout to after-sales service.**

This allows us to adapt to any requirements and satisfy our customers' needs. The most important tasks of the design and development departments include creating new products, improving existing products and meeting the demands of the construction and precast industry with the latest technical challenges adopted with innovative solutions.

**Engineering services:**

- Project management.
- 8 FTE engineers.
- Product design optimization.
- Process and tool development.
- 3D CAD facilities, Autodesk Inventor, Revit, Tekla, BIM.
- Configuration management.
- Innovation.
- In-house test facilities for global homologation.
- Total customer support in project management and product development.



Bridges



Residential towers



Industry buildings



Arenas



Houses



Reinforcement systems



Lifting systems



Fixing systems



Precast concrete systems



Production

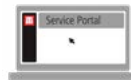

Software



BIM



Construction companies



Precast factories



Architects



Constructors

# QUALITY & CERTIFICATIONS

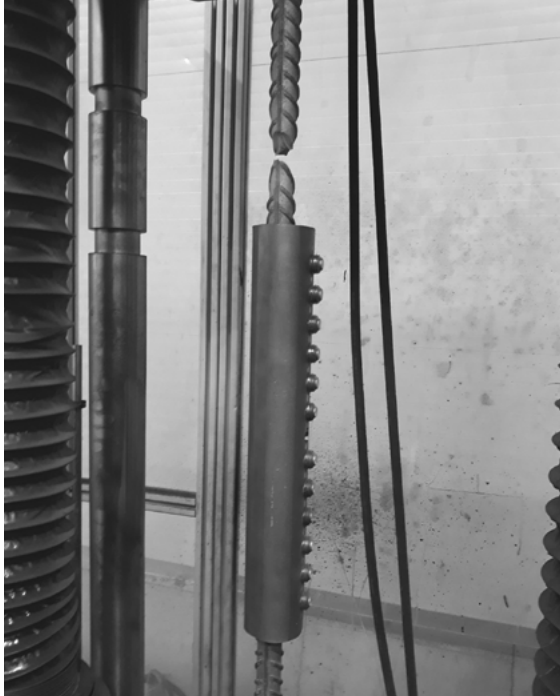



The Terwa Construction Group's main production facility is in Ghimbav, a medium-sized town near Braşov located in western Romania. Over 75 highly skilled employees work at this ultramodern production unit which has a total area of 5,000 square meters.

The organization is entirely self-supporting and in addition to manufacturing, has its own engineering, quality, logistics buying & scheduling, sales & supply, personnel administration and finance departments.

In response to the demands and product specifications of the construction and precast industries, the Terwa group has invested in a stock of modern, advanced machinery which runs seven days per week in a cycle of three eight-hour shifts per day.

As well as investing in production resources, the Terwa group of course invests in its employees. The education and training program is a constant process within the organization as a whole.

The key building blocks behind Terwa's success include consistent quality, produced in an efficient production environment, and innovative production techniques. This is also the foundation which will help Terwa expand and strengthen its position in the construction and precast industry in the future.



Management quality system



Metal component welding system



Environmental management system



# PRODUCTION







# REFERENCES

## PROJECT REFERENCES OF TERWA



**Westrandweg - Amsterdam  
the Netherlands**

The A5 Westrandweg is a motorway spanning approximately 17 kilometers and connects Schiphol Airport with the Western Docklands of Amsterdam. The road runs from junction De Hoek (A4) via junction Raasdorp (A9) to the second Coentunnel.

Terwa products used: **PSA, TSE**  
Terwa product group: **Reinforcement systems**



**Rabobank Executive Centre - Utrecht  
the Netherlands**

The Rabobank Executive Centre or Rabotower is a skyscraper in the Dutch city of Utrecht. Standing at 105 metres (344 ft), it is the city's highest office building, and its second highest building overall after the Dom Tower. In June 2011, it became the new headquarters of the Rabobank.

Terwa products used: **PSA, TSE**  
Terwa product group: **Reinforcement systems**



**Mega image logistic center - Bucharest  
Romania**

In the year 2015, the Belgian group Delhaize, started building a new logistics centre of about 34,000 square meters, located in Stefanesti Bucharest.

Terwa products used: **PSA, TSE, TH2, T-anchors**  
Terwa product group: **Reinforcement systems  
Lifting systems**





**Sky Tower - Bucharest  
Romania**

Rising 42 floors high, SkyTower redefines the skyline of Bucharest. This powerful new landmark introduces a completely new business office concept and was designed to attract corporate tenants.

Terwa products used: **ALC, PSA, TSE**  
Terwa product group: **Reinforcement systems**



**Number one first street - Manchester  
United Kingdom**

This project is set up to emerge as the new cultural home for Manchester, highlighting a new place in the city where business and creativity will come together.

Terwa products used: **PSA, TSE**  
Terwa product group: **Reinforcement systems**



**Wind farms - various locations  
Australia**

Terwa delivered Alligator couplers to a wide variety of wind farm projects around Australia.

Terwa products used: **ALC**  
Terwa product group: **Reinforcement systems**







**Johan Cruyff ArenA - Amsterdam  
the Netherlands**

The Johan Cruyff ArenA is the main stadium of the Dutch capital city of Amsterdam and the home stadium of football club AFC Ajax since its opening. It is the largest stadium in the Netherlands with a capacity of 68,000 people.

Terwa products used: **PSA, TSE, SA-TTU**  
Terwa product group: **Reinforcement systems  
Lifting systems**



**Parking Garage Hoog Catharijne - Utrecht  
the Netherlands**

Parking garage Hoog Catharijne P1 is located in the centre of Utrecht, right below the Hoog Catharijne shopping centre. The parking garage is within walking distance of the Utrecht city center, Utrecht Central Station, Tivoli Vredenburg, the Neude and the Dom tower.

Terwa products used: **PSA, TSE, ALC**  
Terwa product group: **Reinforcement Systems**



**Metro subway M4 & M5 - Bucharest  
Romania**

M5 is the newest of the five lines of the Bucharest Metro, which opened on 15 September 2020. In the first phase (6.87 km (4.3 mi)), it runs from Eroilor to Râul Doamnei, and to Valea Ialomiței, in the Drumul Taberei neighbourhood.

Terwa products used: **PSA, TSE, ALC**  
Terwa product group: **Reinforcement Systems**





**Agigea bridge - Agigea  
Romania**

The bridge over the Danube-Black Sea Channel from Agigea is located at the confluence of the Black Sea and the Channel, near Constanta seaport. The bridge and access viaducts have a total length of 906.82 m, with 362.00 m for the bridge and 544.82 m for the viaducts.

Terwa products used: **PSA, TSE**  
Terwa product group: **Reinforcement Systems  
Terwa Mobile Unit**



**Leadenhall building - London  
United Kingdom**

The Leadenhall building is one of the tallest leading skyscrapers within the skyline of London located in the financial district. The building is 225 metres high and has a distinctive wedge-shaped profile in an angle of 10° degrees.

Terwa products used: **PSA, TSE**  
Terwa product group: **Reinforcement Systems**



**Lighthouse - Aarhus  
Denmark**

It is Denmark's tallest residential building (142 meter), situated at a unique location at the tip of Aarhus Island. Together with the two side buildings - Kanalhuset and Promenadehuset, the lighthouse is a landmark for the whole of Aarhus.

Terwa products used: **PSA, TSE**  
Terwa product group: **Reinforcement Systems**



# LIFTING SYSTEMS

## 1D HEAVY-DUTY THREADED ANCHOR LIFTING SYSTEM



**HD threaded lifting systems are used in the precast industry and are suitable for lifting, transport and installation of precast concrete elements on site.**



Some of the advantages of this system are:

- The 1D-HD lifting anchors are designed to resist at a minimum safety factor of **3x load group**.
- A wide range of lifting sockets.
- Capability of establishing a connection in a safe, simple manner.
- The lifting systems can be re-used.
- CE-compliant system. All Terwa lifting systems have the CE marking which guarantees compliance with the European regulations.

The threaded lifting system combines a lifting anchor embedded in a concrete unit and a lifting device.

Products are available in electrolytic galvanized and hot-dipped galvanized steel and as AISI Grade A2 and A4.

EC Declaration of Conformity, Machinery Directive 2006/42/EC, Section 4.1.2.5, Directive 2009/127/EC Regulation (EU) No 167/2013  
EN ISO 12100:2011-03: Safety of machinery - general design principles - risk assessment and risk reduction  
VDI/BV-BS 6205: 2012-04: Lifting inserts and lifting systems for precast concrete elements - principles, design, applications.  
EN 12385-4 - EN 13414-1

## HEAVY DUTY LIFTING SYSTEMS

THS1



THS3-HD



---

## HEAVY-DUTY LIFTING & TRANSPORT ANCHORS

HBS



HBS WITH BARRIER



TRL- HD



HSP-HD



---

## FIXING ACCESSORIES

SN



KU-10



TPM



TBP



DATA CLIP



TPP

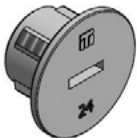

TP-02



TP-10



KU CAP DIE

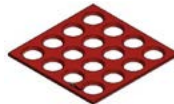



# LIFTING SYSTEMS

## 1D THREADED ANCHOR LIFTING SYSTEM



**Threaded-lifting systems are used in the precast industry and are suitable for lifting, transport and installation of precast concrete elements on site.**



Some of the advantages of this system are:

- A wide range of lifting sockets.
- Threaded lifting loops and cast-in lifting loops.
- Capability of establishing a connection in a safe, simple manner.
- Most of the lifting systems can be re-used.
- CE-compliant system. All Terwa lifting systems have the CE marking which guarantees compliance with the European regulations.
- Economic solution for the assembly of prefabricated units.
- The 1D lifting anchors are designed to resist at a minimum safety factor of **3x load group**.

The threaded lifting system combines a lifting anchor embedded in a concrete unit and a lifting device.

Products are available in electrolytic galvanized and hot-dipped galvanized steel and as AISI Grade A2 and A4.

EC Declaration of Conformity, Machinery Directive 2006/42/EC, Section 4.1.2.5, Directive 2009/127/EC Regulation (EU) No 167/2013  
EN ISO 12100:2011-03: Safety of machinery - general design principles - risk assessment and risk reduction  
VDI/BV-BS 6205: 2012-04: Lifting inserts and lifting systems for precast concrete elements - principles, design, applications  
EN 12385-4 - EN 13414-1



## LIFTING SYSTEMS

THL



THS1



THS3-HD



TIL



TBL



## LIFTING & TRANSPORT ANCHORS

TGK



TGL



TRL



HBB



HSB



HSB WITH STOPPER



HSR



HSP



HBP



## FIXING ACCESSORIES

SN



DATA CLIP



KU-10



TPP

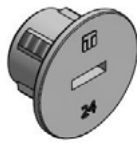

TPM



TP-02



KU-02



TP-10



TBP



KU CAP DIE

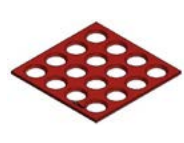

# LIFTING SYSTEMS

## 2D STRIP ANCHOR LIFTING SYSTEM



**The strip anchor lifting system manufactured by TERWA is a high quality, safe, easy to handle, cost-effective system. It is used for transporting all types of concrete elements.**



Some of the important advantages of these systems are:

- Safe, simple and fast connection and disconnection between lifting anchor links.
- Anchors and links are designed for load capacities between 0.7 - 26.0 t.
- High-quality alloy material for lifting anchors can be used in any environment.
- Perfect lifting and transport solution for most applications and precast elements.
- CE-certified system. All Terwa lifting systems have the CE marking which guarantees compliance with the European regulations.
- The anchors are designed to resist at a minimum safety factor = 3.

Products are available in electrolytic galvanized and hot-dipped galvanized steel and as AISI Grade A2 and A4.

EC Declaration of Conformity, Machinery Directive 2006/42/EC, Section 4.1.2.5, Directive 2009/127/EC Regulation (EU) No 167/2013  
EN ISO 12100:2011-03: Safety of machinery - general design principles - risk assessment and risk reduction  
VDI/BV-BS 6205: 2012-04: Lifting inserts and lifting systems for precast concrete elements - principles, design, applications  
EN 12385-4 - EN 13414-1

## LIFTING CLUTCHES AND TRANSPORT ANCHORS

SA-B



SA-ST



SA-TTU



UNIVERSAL ANCHOR  
1.25 kN



SA-TU-HP



SA-FA



SA-FAW



SA-SP



SA-LSP



TF1



TF1-260



TF2



---

## RECESS FORMERS AND ACCESSORIES

RBF



RBFM



TMP



TDV



TBV



# LIFTING SYSTEMS

## 3D T-SLOT ANCHOR LIFTING SYSTEM



Using the 3D T-slot anchor system is fast, and the utilization of a cheap T-slot anchor makes application of this lifting system the most economical system. The T-slot anchor is built into the concrete element with the aid of a rubber recess former. After pouring the shuttering and after the concrete has hardened, the rubber ball can be removed. The TH2 lifting clutch fits perfectly in the hole created, facilitating pulling the precast element up out of the shuttering.



EC Declaration of Conformity

Some of the important advantages of these systems are:

- Safe, simple and fast connection and disconnection between lifting anchors and lifting clutches.
- Anchors and links are designed for load capacities between 1.3 - 45 t.
- High quality alloy material for lifting anchors can be used in any environment.
- Perfect lifting and transport solution for most applications and precast elements.
- CE-certified system. All Terwa lifting systems have the CE marking which guarantees compliance with the European regulations.
- The anchors are designed to resist at a minimum safety factor = 3.

Products are available in electrolytic galvanized and hot-dipped galvanized steel and as AISI Grade A2 and A4.

EC Declaration of Conformity, Machinery Directive 2006/42/EC, Section 4.1.2.5, Directive 2009/127/EC Regulation (EU) No 167/2013  
EN ISO 12100:2011-03: Safety of machinery - general design principles - risk assessment and risk reduction  
VDI/BV-BS 6205: 2012-04: Lifting inserts and lifting systems for precast concrete elements - principles, design, applications  
EN 12385-4 - EN 13414-1

## LIFTING CLUTCHES AND TRANSPORT ANCHORS

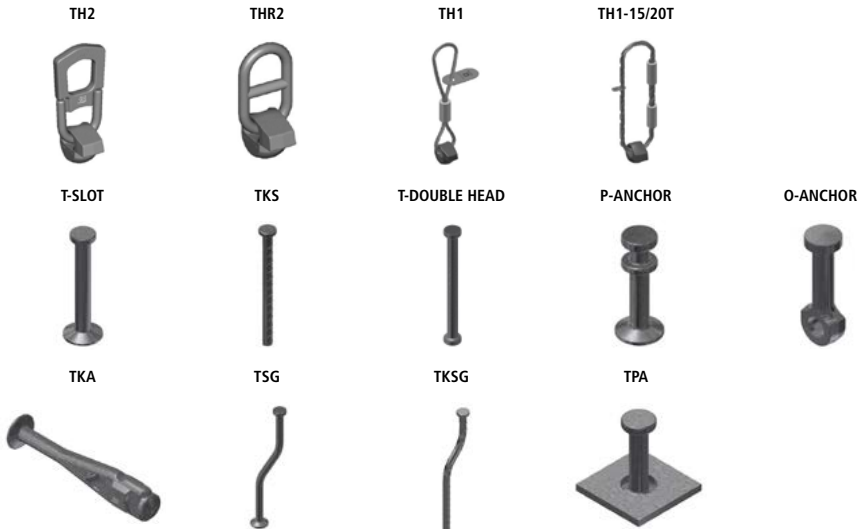

## RECESS FORMERS AND ACCESSORIES





# FIXING SYSTEMS

## FIXING INSERTS



**Fixing systems are used in the precast industry and are suitable for installation of precast concrete elements on site.**



Some advantages of this system:

- A wide range of fixing sockets.
- Capability to establish a connection in a safe, simple manner.

Fixing inserts:

- Fixing socket embedded in precast concrete unit.
- Ready for mounting bolts.

Connecting elements and fixing accessories:

- Thread connections.
- Fixing accessories.

Products are available in electrolytic galvanized and hot-dipped galvanized steel as AISI Grade A2 and A4.

EC Declaration of Conformity, Machinery Directive 2006/42/EC, Section 4.1.2.5, Directive 2009/127/EC Regulation (EU) No 167/2013  
EN ISO 12100:2011-03: Safety of machinery - general design principles - risk assessment and risk reduction  
VDI/BV-BS 6205: 2012-04: Lifting inserts and lifting systems for precast concrete elements - principles, design, applications

## FIXING INSERTS

BSR



BSRS



BSH



BSHF



BSRF



BSRFS



BSX



HBU



HBUS



BBB



BBP



SB



SB-SB



---

## ACCESSORIES

SN



KU-02



KU-10



TPM



TBP



TFB



# FIXING SYSTEMS

## ANCHOR RAILS



**Anchor channel rails, in combination with T-bolts or hook bolts and serrated retainer anchors, provide a reliable, rapid and low-cost solution for any problem with fastenings for prefabricated concrete units.**

The anchor channels are stuffed with filler to prevent concrete ingress. After the concrete has dried, remove the fillers from the channels leaving an open slot in the wall for fixture connections.

The T-bolts, hook bolts and anchors can now easily be mounted on the anchor channel rails in a safe way. This system can be used in a wide range of construction works.

Anchor rails are available in hot-dipped galvanized steel and A4 stainless steel.

---

### ANCHOR CHANNEL RAILS

COLD-ROLLED



HOT-ROLLED



---

### MOUNTING RAIL

HMPB-P unperforated



HMPB-S perforated



---

### FASTENING RAIL

TU



---

### ANCHOR CHANNEL ACCESSORIES

H5 T headed bolt



HZ5 T headed bolt



HWT-MA wall connection anchor



HWT anchoring bracket with counter plate



MAS wall connection rail



E5 short piece with loop



# REINFORCEMENT SYSTEMS

## REBAR CONNECTION SYSTEM



**Terwa rebar connection system is a high quality, economical connection system of reinforcement.**

**Some of the characteristics and advantages of the Terwa rebar connection system are:**

- Used for reinforcement steel with a diameter from 10 mm to 40 mm.
- Suitable for dynamic and seismic loads.

**Suitable for all types of reinforcement steel according to the European and American standards.**

- B500A, B500B according to NEN 6008
- B450C, B500A, B500B, B500C according to EN 10080.
- B500B, B500C according to BS4449.
- B500A, B500B, B500C according to DIN 488
- B500A, B500B, B500C according to NF A35-080-1
- B500A, B500B, B500C according to SFS 1300
- K500B-T, K500C-T according to SS-EN 10080 + SS 212540
- B500NC according to NS-EN 10080+NS 3576
- B550B according to EN 10080 and ÖN 4707

Products are available in electrolytic galvanized and hot-dipped galvanized steel and as AISI Grade A2 and A4.



Deutsches  
Institut  
für  
Bautechnik



RI  
SE



eurofins





## STANDARD MECHANICAL SPLICES

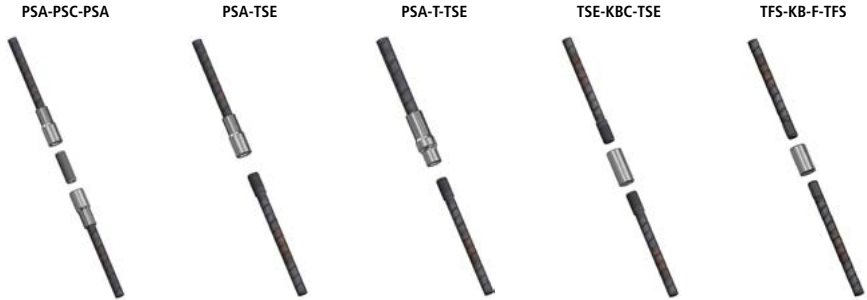

## SPECIAL MECHANICAL SPLICES



## ACCESSORIES / TOOLS

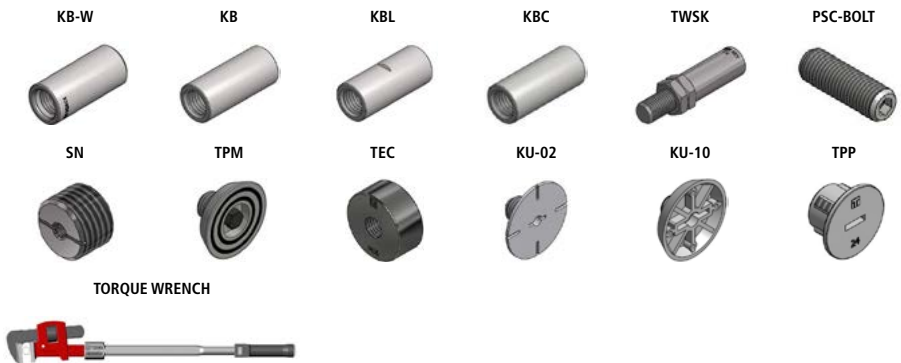

# REINFORCEMENT SYSTEMS

MECHANICAL SPLICES ONSITE THREADING AND COUPLER SYSTEMS



## MECHANICAL SPLICES ON SITE COUPLER SYSTEM

The Terwa mobile units are created for the need to optimize and streamline the work of the builders at the construction sites and to have the products available on site in the fastest way possible. At this time, Terwa owns various fully equipped mobile units that can be used to press couplers on a length of 1-12 meters of rebar steel or, occasionally, even longer lengths.

### Properties and benefits of the mobile unit for rebar coupling include:

- Local installation for the direct connection of rebars with diameters between 10 and 40 mm.
- Completely self-supporting, including necessary energy supply.
- Tested and certified to national and international standards.
- Possibility to use locally supplied reinforcing steel.

### Product variants:

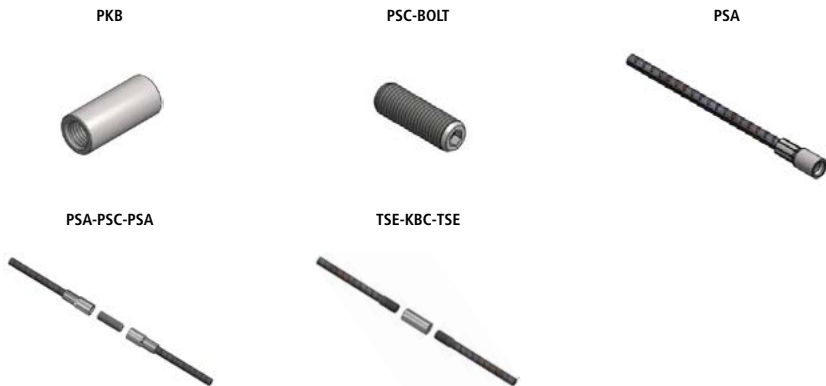

## MECHANICAL SPLICES ON SITE THREADING SYSTEM

### Threaded bars on site

The mobile units for threaded bars on site provide a simple and fast way of connection the rebars on site. The splicing system is designed for the connection of reinforcement steel bars from Ø10 to 40 mm.

The system is produced using 3 machines with high productivity:

- Cutting machine.
- Upset cold forging machine.
- Threading machine.

Connection consists in a threaded bar which is connected using a threaded coupler. Before threading, the bar is first cut so it has a straight surface, after the diameter of the rebar is enlarged to increase the nominal area and the strength.



# REINFORCEMENT SYSTEMS

## ALC ALLIGATOR COUPLERS



Deutsches  
Institut für  
Bautechnik



Alligator couplers are used for splicing any grade or profile of reinforcing steel bar. These couplers are made of reinforcement steel with diameters in the range of 10 mm to 40 mm. Connection is made by inserting bars into both ends of the coupler. The breaking bolts are then screwed on by hand and tightened with a ratchet wrench until the bolts shear off. In specific cases, these couplers can be used to replace the damaged reinforcements with new ones and to connect to the old structure.

**The advantages of alligator couplers are:**

- Ensure integral connection for steel reinforcement.
- No need for threading or any other bar preparation.
- Fast, simple and easy to use.
- The use of ALC rules out the use of lap splices ensuring less congestion and saving rebar material.
- No special training needed.
- Correct assembly is easy to check visually.

**COUPLERS**



**ACCESSORIES**

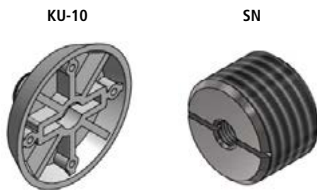

**TOOLS**





# REINFORCEMENT SYSTEMS

TSB TERWA STARTER BOXES



Terwa starter boxes are composed of longitudinal steel profiles (rails), made of perforated, galvanized steel plate with ribbed reinforcement bars mounted into them. These rebar loops are bent into the profile which is sealed off with thick protective tape to prevent concrete from entering during casting. After demolding the tape can be removed to bend out the rebar loops and splice them with the adjacent rebar.

TSB, when cast into concrete, can be used to make vertical and horizontal connections in rebar cages in joints in both precast and in-situ structures such as, wall-wall connections and wall-floor connections.

The modular nature of the starter box allows for fast and continuous application of the product which will reduce labor costs and eliminates manual splicing of stirrups and hairpins into the rebar cage.

### TSB TERWA STARTER BOXES

TSB - TYPE S



TSB - TYPE WH



TSB - TYPE W



TSB - TYPE H



TSB - TYPE TP



TSB - TYPE TW



### TSB TOOLS

PIPE SHAPED FERRULE WITH LATCH



BAR BENDING FERRULE



# REINFORCEMENT SYSTEMS

## PUNCHING AND SHEAR REINFORCEMENT SYSTEM

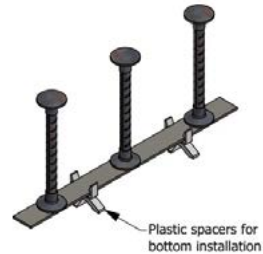
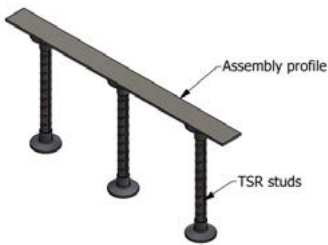
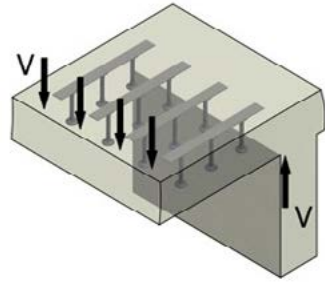
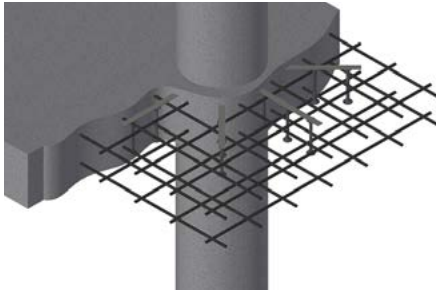



The Terwa shear reinforcement system consists of double headed studs connected by an assembly profile – a strip of flat steel. The products designed and manufactured by Terwa ensure a much simpler installation than other traditional reinforcement elements (stirrups). This applies in both cases – when Terwa shear reinforcement system is used in cast-in situ or in precast elements. It is a fully integrated system in prefabricated elements, which therefore makes it an ideal system for thin monolithic structures or flat concrete slabs.

**TSR - shear reinforcement ensures:**

- Higher punching resistance than conventional stirrup reinforcement.
- Simple and efficient installation.
- Low formwork costs.
- Optimum use of space - a large distance between supporting columns.
- Easy installation from above and below.
- Easier installation of building utilities under slabs, such as pipes or ducts.

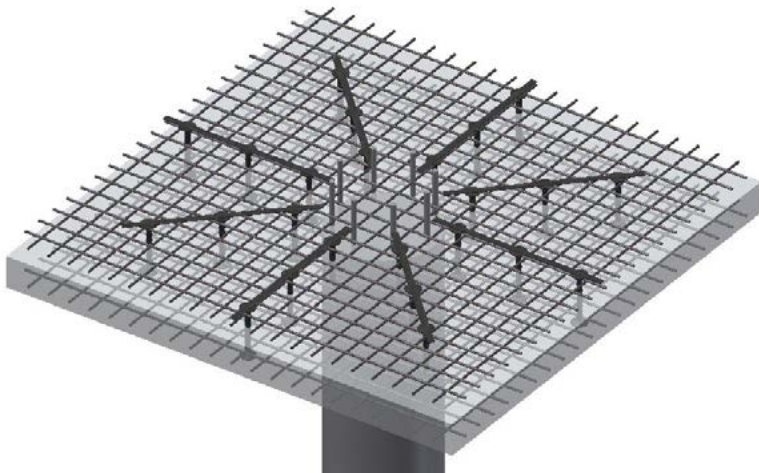

**PUNCHING AND SHEAR REINFORCEMENT SYSTEM**

**TSR**



**TPS SPACERS**



# REINFORCEMENT SYSTEMS

## GROUT COUPLER





Grout couplers connect structural concrete components used in building construction and civil engineering projects. These couplers ensure the tensile strength equal to or greater than that of the rebar by filling hardening grout in the sleeve where the rebars are inserted. The grout coupler is the world's first grout-filled mechanical rebar splice, which has been specifically developed to securely connect precast concrete structural members.

Grout couplers are distinguished by their excellent strength, rigidity and toughness. The product is widely used in high-rise buildings and has a proven track record of preventing structures from collapsing as a result of natural disasters like earthquakes.

The grout specimen fabricated at various job sites is being tested in laboratories on a daily basis to ensure the quality and safety of the grout coupler and provide customers with reliable and stable products.

**The main advantages of grout couplers include:**

- Improved seismic resistance: grout couplers contribute in reducing damage to buildings and structures caused by external forces, such as earthquakes, tsunamis and floods. By connecting rebars to achieve a performance equivalent to the rebar, the structural integrity is enhanced, resulting in improved seismic resistance.
- Repair and reinforcement: grout couplers allow the repair of aged or damaged buildings, making them habitable again without significant destruction. For example, if part of a reinforced concrete building is damaged, it can be cut out and repaired using our grout coupler system. Reusing buildings reduces the production of new rebar and waste disposal, promotes the efficient use of resources and transforms them into more substantial buildings than when they were initially built.
- Improved energy efficiency: the combination of precast construction and our grout coupler system shortens the construction time and creates very strong buildings. A shorter construction period reduces energy consumption at construction sites and the CO2 emissions associated with the construction process. In addition, energy efficiency is improved through reusing rebars, reducing waste and minimizing labour costs. Such efforts help advance the construction industry in a more sustainable direction, achieving high-quality buildings while reducing the environmental burden.

Thanks to these advantages, grout couplers are recognized around the world as a construction material with a positive environmental impact. The benefits include extending the service life of buildings, conserving resources and reducing waste, preserving local landscapes and enabling the construction of buildings and infrastructure that protect people from disasters. It is a technology that proves invaluable in the construction industry, promoting the construction of sustainable structures while mitigating environmental impacts.



# PRECAST CONCRETE SYSTEMS

## SANDWICH PANEL SYSTEMS



**Sandwich panels are multiple-layer, prefabricated, large-format façade panels with good thermal transmittance resistance. They generally combine a design load-bearing layer, the thermal barrier coating, and the facing layer.**

The sleeve and flat anchors and the wire sandwich panel anchors are supplied in stainless steel. Sleeve anchors, flat anchors and wire sandwich panel anchors are available in various dimensions so all technical requirements can be satisfied.





**COMPOSITE PANEL ANCHOR**

MANCHET "TMA"



**FLAT ANCHOR**

PLATE "TFA"



**WIRE HAIR PINS**

TVH



TVA



TVB



**TSPA DOUBLE WIRE**



**TSPA SINGLE WIRE**



# PRECAST CONCRETE SYSTEMS

TERWA PRECAST CONNECTOR



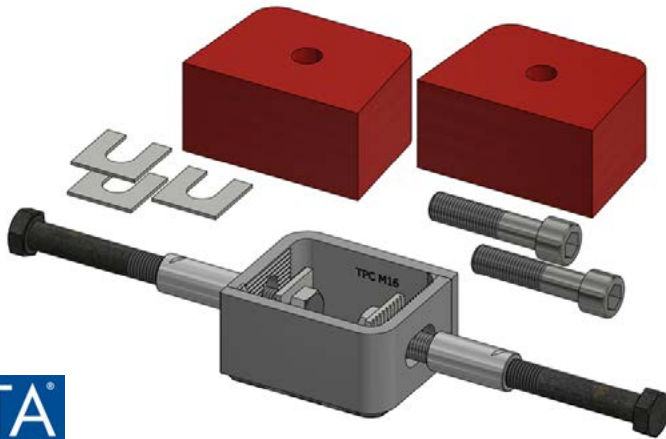

**Terwa Precast Connector "TPC" is a connection system for precast concrete elements, such as walls and shafts, etc.**

Advantages:

- Quick and efficient connection of precast elements. The installation of precast elements does not depend on the weather.
- Can be used in combination with threaded fixing anchor TGK, TGL, HSP, fixing bolt anchor BBB or BBP, fixing inserts HBU, HBUS
- Simple connection solution without additional materials.
- Lightweight.
- Easy mounting in the precast factories and on site.
- Cost and time savings. The connections can be loaded to their maximum load capacities directly after installation.

The Terwa Precast Connector is made of steel S355 electrolytical, or hot dip galvanised. The product can be available for different load group range in function of the panel dimensions and the forces applied on the structure.

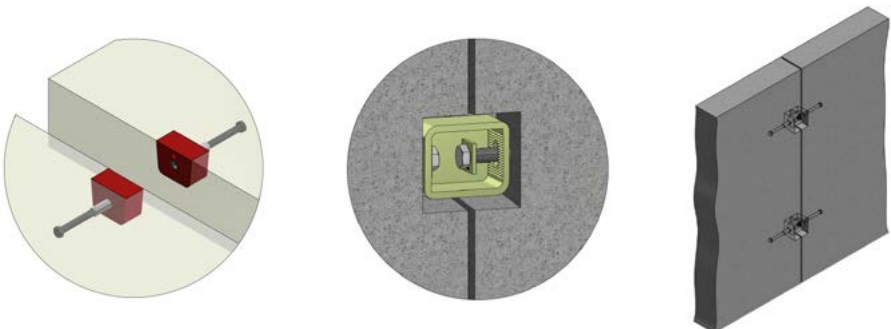



# PRECAST CONCRETE SYSTEMS

## LOOP BOXES



Terwa loop boxes are designed to connect two concrete elements by means of cast-in loop boxes that are laced with additional rebar in combination with a grouted joint. The connection is able to transfer vertical shear forces, transverse shear forces, tensile forces, and their combinations in wall to wall or wall to column connections.

This system consists of a flexible cable loop mounted inside a steel box which also functions as a cavity former. The wire rope loop is made from a high strength cable of which loose ends are pressed into a steel sleeve. The boxes can be nailed onto the formwork via holes in the steel box. After demolding the loops are easily pulled out by removing the protective tape.

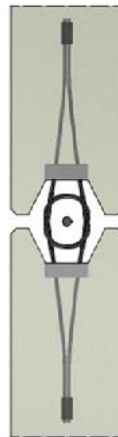
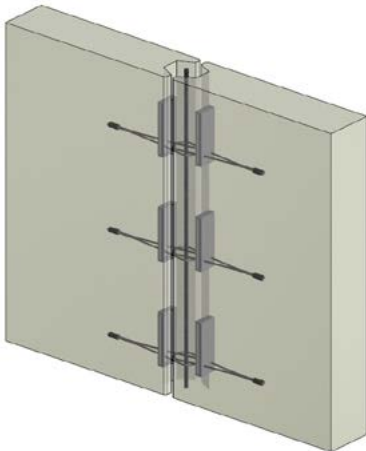

Terwa Loop Box	Article number
TLB-060	63591
TLB-080	63592
TLB-100	63593
TLB-120	63594
TLB-140	63595

# COLUMN CENTRALIZERS



Column centralizers represent an optimal solution for concrete columns fastening, facilitating the installation on site, saving time and ensuring the correct position of the concrete columns in foundation. The system consists of two spherical connectors made from sheet steel.

The two connectors are embedded in the column and foundation block, ensuring a joint between the two elements. For this reason, we recommend ordering these connectors in pairs. The connectors have four bended corners, specially designed for good embedment in concrete. The design ensures a good position in the concrete element and an easy installation.

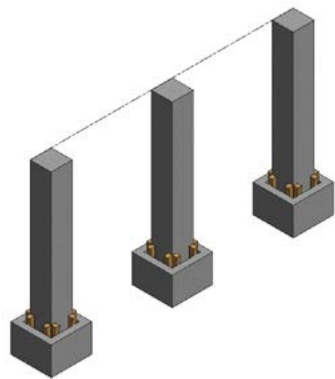
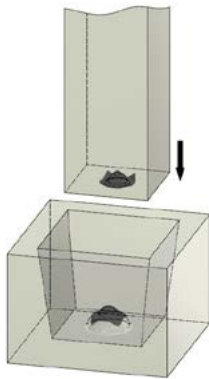

---

## COLUMN CENTRALIZERS

FOUNDATION CONNECTOR



COLUMN CONNECTOR

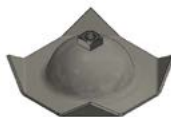

TDV



# FASTENING PRODUCTS

## FASTENING PLATES



**Terwa fastening plates are steel parts used to transfer the loads of structural elements to concrete. Structural fixings are made by welding to the steel plate. TFPT, TFP and TFPR fastening plates are steel parts that are installed before the concrete hardens. The fastening plates are available for all sorts of loading situations and are available in three types with different studs welded on a steel plate.**

Properties and benefits of the fastening plates include:

- No commercial or technical limitations; free movement of the products across borders.
- Ease of design: pre-calculated capacities can be used together with Eurocode all over the EU.
- Products authorized for CE-marking as they fulfil the required quality and safety criteria.
- Pre-calculated capacities speed up the design work.
- Standardized products enable fast delivery directly from storage.
- Multitude of material options and combinations enables use in even the most demanding circumstances.
- Different types of fastening plates available for all sorts of loading situations.

### TFPT FASTENING PLATES

A TFPT fastening plate consists of an S355J2 steel plate (EN 10025) and studs made of a S355J2 steel bar, forged on one side and welded on to the plate.



---

### TFPR FASTENING PLATES

A TFPR fastening plate consists of an S355J2 steel plate (EN 10025) and ribbed studs made of B500B reinforcement steel (EN 10080), hot-forged on one side and welded on to the plate.



---

### TFP FASTENING PLATES

A TFP fastening plate consists of an S355J2 steel plate (EN 10025) and ribbed studs made of B500B reinforcement steel (EN10080), welded on to the plate.

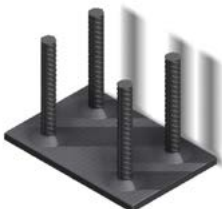



# SPECIAL CONSTRUCTION PRODUCTS

## BALCONY COLUMN FENCE SOLUTION



### Terwa balcony system with stainless steel handrail

This system is made from steel and is hot-dip galvanized after. The profile is welded on to a steel fixing flange with adjustable holes for proper alignment of the whole system. The uprights are fixed outside the concrete slab to enable use of the entire surface of the balcony.

The uprights are fixed outside the concrete slab using Terwa fixing anchors, as shown in the picture above. The uprights can be painted by the clients. We also offer painting services and only require the exact RAL color specification.



### Terwa fence balcony system

This type of balcony system is created for residences and office buildings. It is made from hot-dip galvanized steel. The uprights can be painted by the clients. We also offer painting services and only require the exact RAL color specification.

The system is very safe, as it is made from cut and bent steel plates with a thickness of 6 mm and 4 mm, respectively. The system consists of two parts. The first part is on the inside and ensures the rectangular profile does not go outside and gives strength to the whole system. The second part is on the outside, is closed and ensures the whole system stays fixed. These two parts are mounted with safety screws.

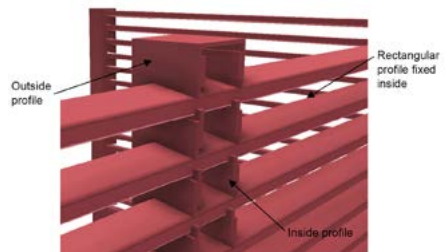
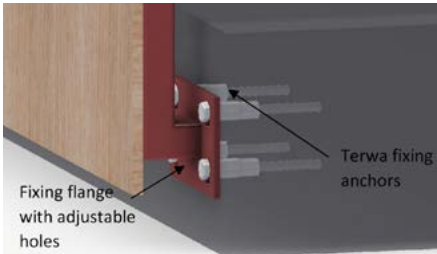

# PANEL FIXING SOLUTION



Our TFPS products are specially designed for fixing façade concrete precast panels on metal structures. The innovative design assures a safe fixing for the concrete panels, perfect alignment on the façade using the adjustable system on 3 directions.

The system components are:

## 1 Fixing anchor

The anchor consists of one steel plate with two threaded holes M16 or M12 and two reinforcement steel B500B bars bent and calculated to assure the needed embedding in the concrete.



## 2 L profile system

The L profile assures the connection between the metal structure and the concrete panels. Also, the profile system is adjustable to align the panels on the structure.

Special fixing anchor

Adjusting system with in 3 directions



## 3 Panel alignment and lifting system PSAD

The product consists of a reinforcement steel with two bushes pressed at both sides. The bushes and the connection pin are made of stainless steel AISI 316 Ti.

PSAD product from standard Tenwa range 2 pcs / panel.

Double function:

- Maneuvering of the panel (anchor system);
- Guiding the panel in position with the inferior panel using a special "guiding Pin".

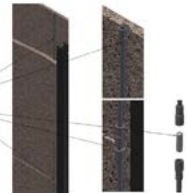

## 4 base L profile system

The base profile is used to fix the base concrete panels on the metal structure.



# CONTACT DETAILS



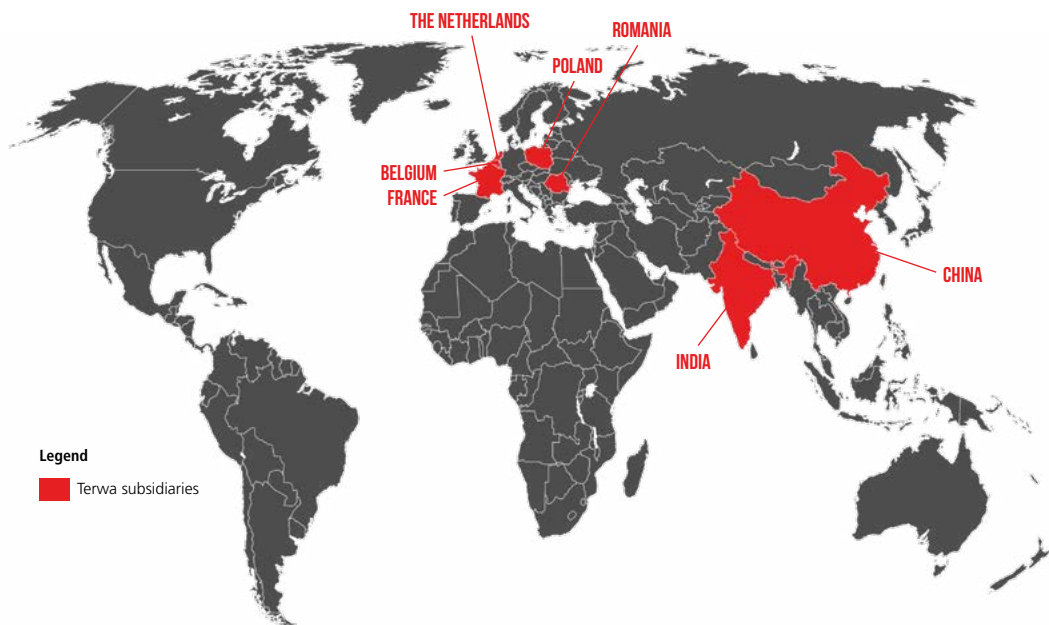

**Legend**  
■ Terwa subsidiaries

TERWA is the global supplier for precast and construction solutions with multiple offices around the world. With all our staff, partners and agents, we are happy to provide all construction and precast companies who work in the building industry with full service and 100% support.

## TERWA CONSTRUCTION GROUP

**Terwa B.V. (HQ)**  
**Global Sales & Distribution**  
 Kamerlingh Onneslaan 1-3  
 3401 MZ IJsselstein  
 The Netherlands  
**T** +31-(0)30 699 13 29  
**E** info@terwa.com

**Terwa Construction Central East Europe**  
**Sales & Distribution**  
 Strada Sănzieni  
 507075 Ghimbav  
 Romania  
**T** +40 372 611 576  
**E** info@terwa.com

**Terwa the Netherlands**  
**Sales & Distribution**  
 Kamerlingh Onneslaan 1-3  
 3401 MZ IJsselstein  
 The Netherlands  
**T** +31-(0)30 699 13 29  
**E** info@terwa.com

**Terwa Belgium**  
**Sales & Distribution**  
 Kamerlingh Onneslaan 1-3  
 3401 MZ IJsselstein  
 The Netherlands  
**T** +32-467 00 20 62  
**E** info@terwa.com

**Terwa France**  
**Sales & Distribution**  
 Kamerlingh Onneslaan 1-3  
 3401 MZ IJsselstein  
 The Netherlands  
**T** +31-(0)30 699 13 29  
**E** info@terwa.com

**Terwa Construction Systems Sp. z o.o.**  
**Sales & Distribution**  
 ul. Cicha 5 lok. 4  
 00-353 Warsaw  
 Poland  
**E** info@terwa.com

**Terwa International**  
**Sales & Distribution**  
 India  
**T** +91 89 687 000 41  
**E** info@terwa.com

**Terwa Construction China**  
**Sales & Distribution**  
 B05, 5F, No.107, 2nd of the South Zhongshan Road, 200032, Shanghai  
 China  
**E** info@terwa.com

**WWW.TERWA.COM**

Disclaimer: This company brochure is designed to inform you about Terwa B.V. and its products and services. Although all information has been carefully selected, we cannot guarantee it is free of inaccuracies. Terwa B.V. is not liable for the consequences of using information from this brochure. Terwa B.V. is not liable for problems or technical malfunctions caused by the dissemination of this information. The information in this brochure is not legally binding. The contents of this brochure may not be reproduced or distributed without the specific written permission of Terwa B.V. Copyright Terwa B.V. 2021



