

## TECHNICAL DOCUMENTATION

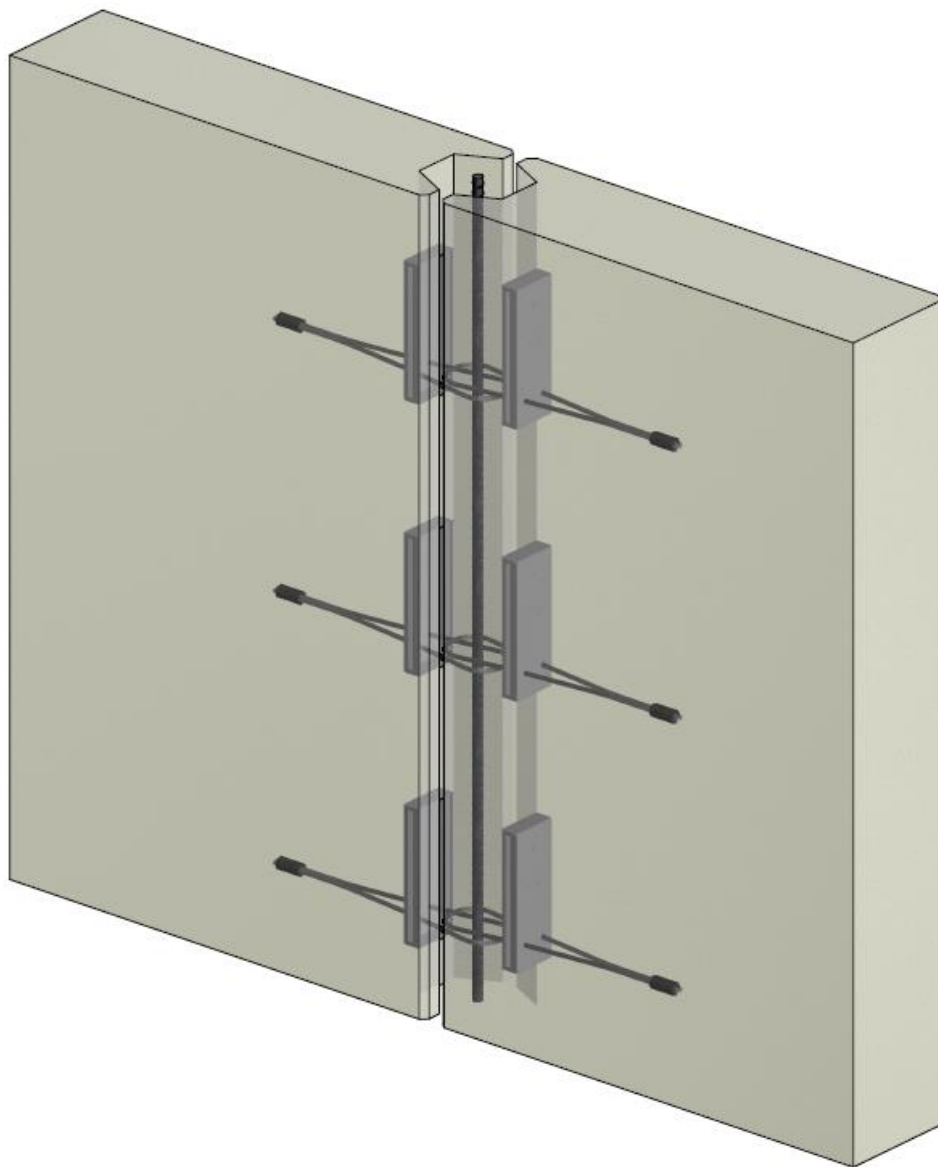

## PRECAST CONCRETE SYSTEMS | **LOOP BOX**



**TABLE OF CONTENTS:**

<b>GENERAL PRESENTATION .....</b>	<b>3</b>
<b>PRODUCTION PROCESS .....</b>	<b>3</b>
<b>TECHNICAL DATA .....</b>	<b>4</b>
<b>APPLICATION .....</b>	<b>5</b>
<b>DESIGN DATA .....</b>	<b>6</b>
<b>MINIMUM EDGE DISTANCE AND THE MINIMUM DISTANCE BETWEEN THE CENTRES OF LOOPS .....</b>	<b>7</b>
<b>REINFORCEMENTS .....</b>	<b>8</b>
<b>INSTALLATION INSTRUCTIONS.....</b>	<b>11</b>
FIXING TO FORMWORK.....	11
CASTING OF PRECAST ELEMENT .....	12
DE-MOULDING .....	12
CASTING JOINT .....	12
<b>STORAGE REQUIREMENTS .....</b>	<b>12</b>
<b>CONTACT .....</b>	<b>13</b>
<b>DISCLAIMER .....</b>	<b>13</b>

## GENERAL PRESENTATION

Terwa loop box – a simple and fast connection of precast concrete elements (walls and columns, etc.)

## THE MAIN ADVANTAGES OF THIS SYSTEM

- Wide range of application with a small range of sizes
- Using steel cable instead of bent reinforcing bars which require unbending when mounting reduces installation time.
- Greater adaptability of concrete elements
- Rust protection – all metal components of the TLB system are galvanised.
- Reduced risk of accidents on site - without protruding reinforcement bars.
- Easily fixed to the formwork - with nails, magnet or adhesive according to the type of shuttering
- Easy installation between mesh reinforcements due to small size steel box
- The design of steel box prevents changing shape during use

## SYSTEM DESCRIPTION

Terwa loop box is designed to transfer vertical shear forces, transverse shear forces, tensile forces, and their combinations in wall to wall or wall to column connections. They are used for assembling the precast concrete elements. This system consists of a flexible cable loop mounted inside a steel box. The wire rope loop is made from a high strength cable of which loose ends are pressed into a steel sleeve. These systems are used for joints of walls extension, corner joints or wall-ceiling joints. In this way, joints are made at low cost, easily and safely. We recommend using high strength, self-compacting mortar with very good flow qualities is recommended for casting the recess of joints. The connection can be assumed as load bearing only after grouting has reached the required strength.

Terwa loop boxes are designed to transfer predominantly static loads and can be used in indoor or outdoor condition. The steel box and the wire cable are galvanised.

***Do not use this product for lifting wall elements or other concrete elements.***

## PRODUCTION PROCESS

The TLB box is made of sheet metal by cutting and successive bending operations carefully checked. The cable wire is inserted into the metal box and then pressed in a steel sleeve forming a loop. The wire rope loop is folded and placed in the steel box which is then closed with a flexible tape to prevent ingress of grout when pouring precast elements.

The TLB wire rope loop box is made of a 0.5mm thick steel sheet.

Component	Material	Standard
Steel box	DC01 ZE Galvanised metal sheet	EN 10152
Wire cable	High-strength steel wire rope -Zn – Minimum braking load 1770 MPa	EN 12385
Pressing sleeve	S355J0	EN 10025
Protective tape		

## TECHNICAL DATA

The box shape is designed to ensure good adherence with the concrete.

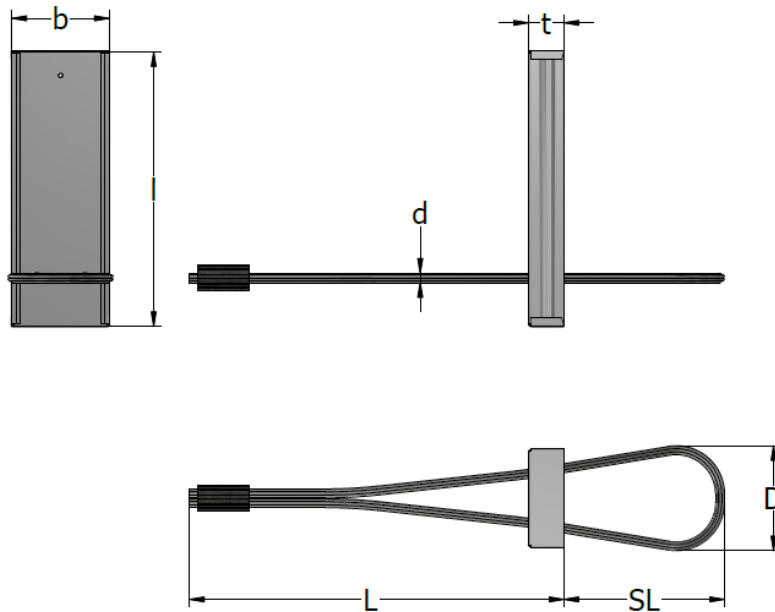

## DIMENSIONS AND TOLERANCES FOR TERWA LOOP BOXES

Terwa Loop Box	Article number	SL	L	l	b	t	d	D
		[mm]	[mm]	[mm]	[mm]	[mm]	[mm]	[mm]
TLB-060	63591	60	210	160	50	20	6	60
TLB-080	63592	80	210	160	50	20	6	60
TLB-100	63593	100	210	160	50	20	6	65
TLB-120	63594	120	210	160	50	20	6	70
TLB-140	63595	140	370	200	70	30	8	100

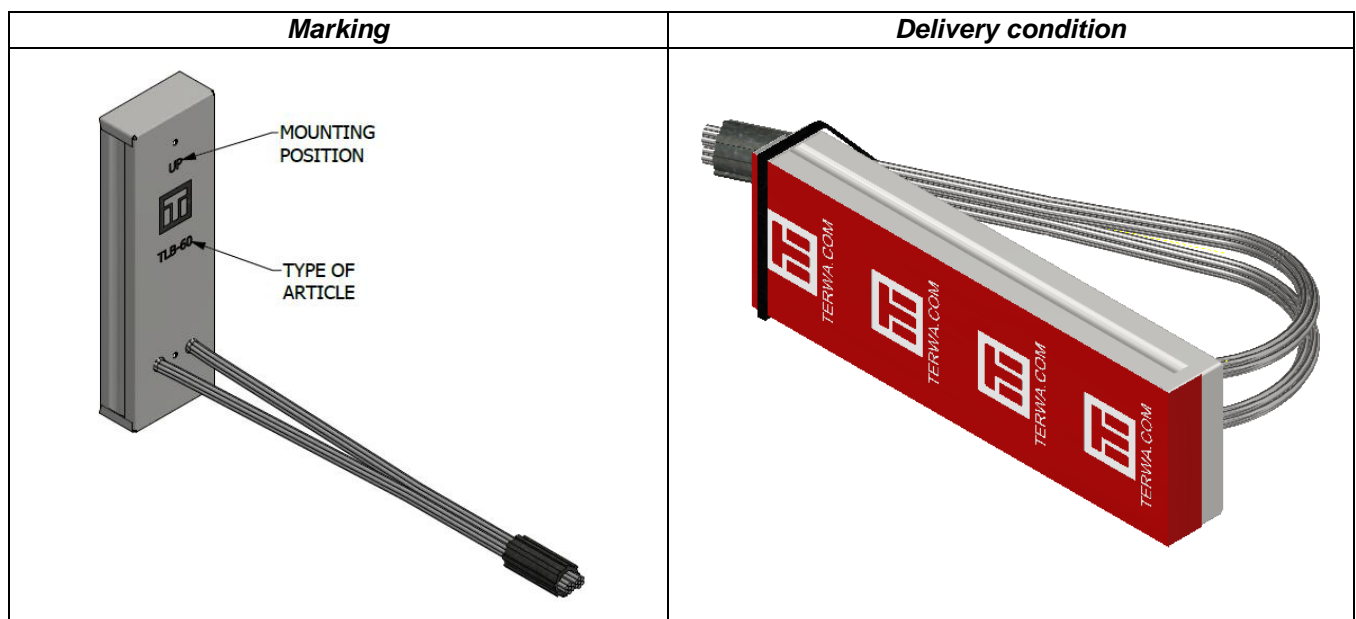

## APPLICATION

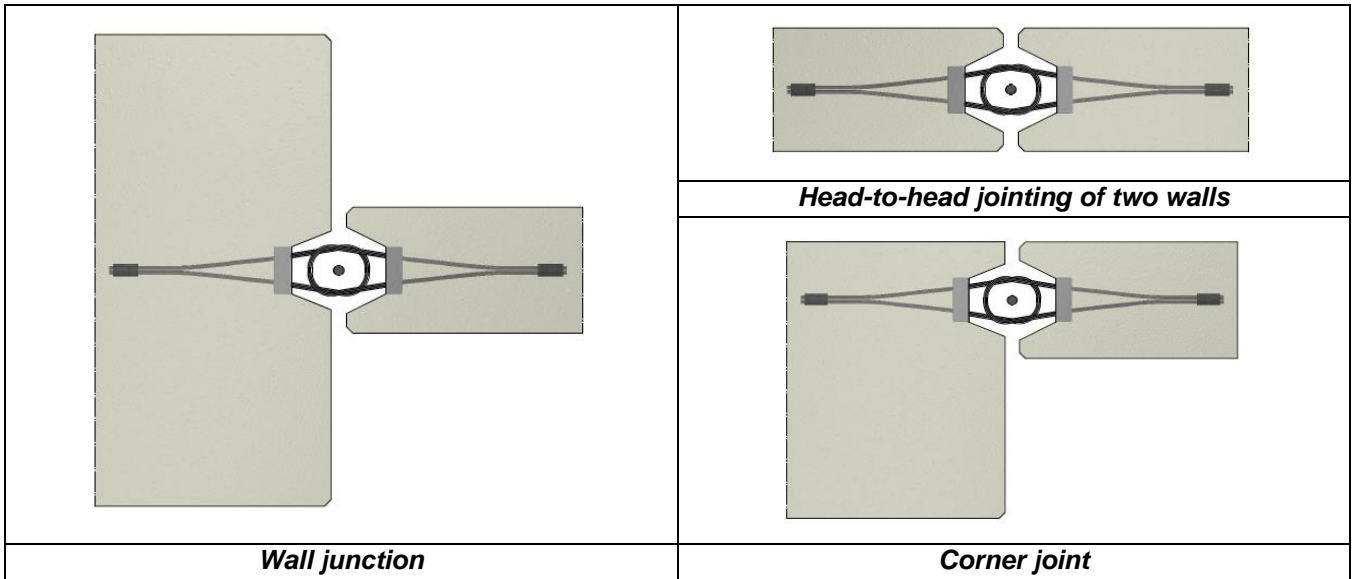

## INSTALLATION DIMENSIONS AND REINFORCEMENT

The **Terwa loop boxes** must not interact with one another when several TLB boxes are placed above one another. Minimum recommended reinforcements are illustrated below: two layer of mesh reinforcement, B500B stirrups Ø8, two longitudinal bar B500B Ø10. National regulations have local priority over this recommendation.

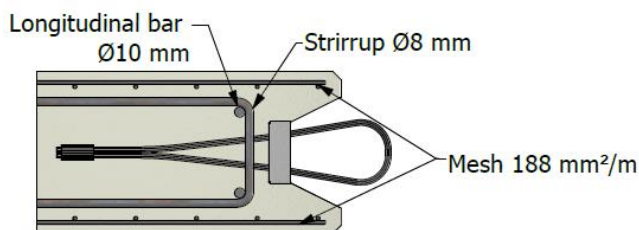
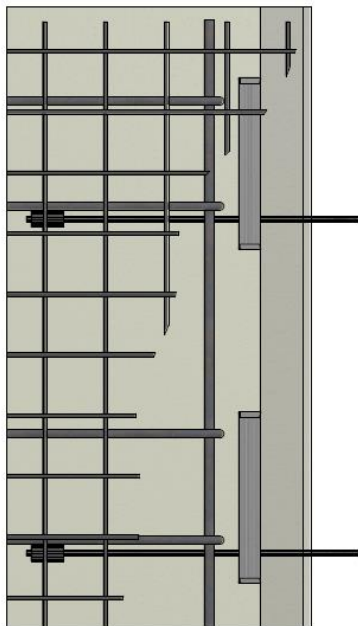

**Terwa Loop Boxes** are used as an overlapping joint and for that reason the loops must lie above one another. These are available when the product boxes are installed in formwork in the same way, from the base of the elements.

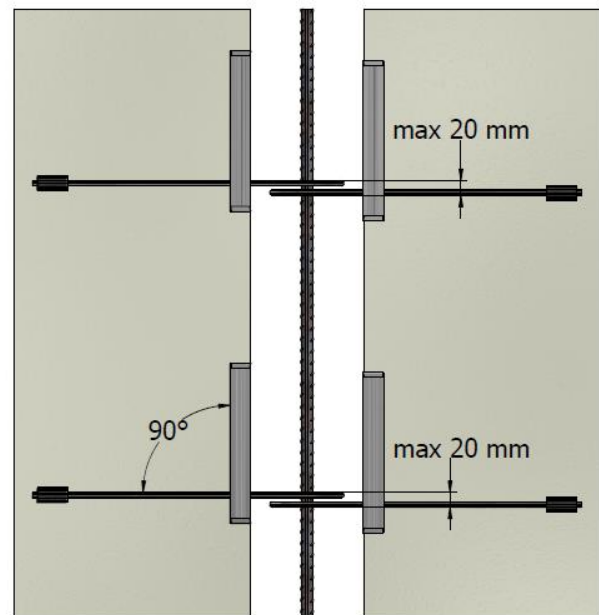

## DESIGN DATA

### GENERAL INFORMATION

Load capacity is calculated for static loads in the case of joints with dimensions shown in the picture below. The calculations take no account of cracks and deformations of the joints. Terwa Loop Boxes are designed to connect walls or columns with minimum concrete strength 25/30 MPa or higher and the grouting material must have at least the same compressive strength as the precast concrete element.

The length of wire rope loop and the recess dimensions must be matched to ensure a suitable overlapping of the wire loops and to guarantee full carrying capacity. There should be enough space in the casting recess for the loops in the unfolded state without hitting.

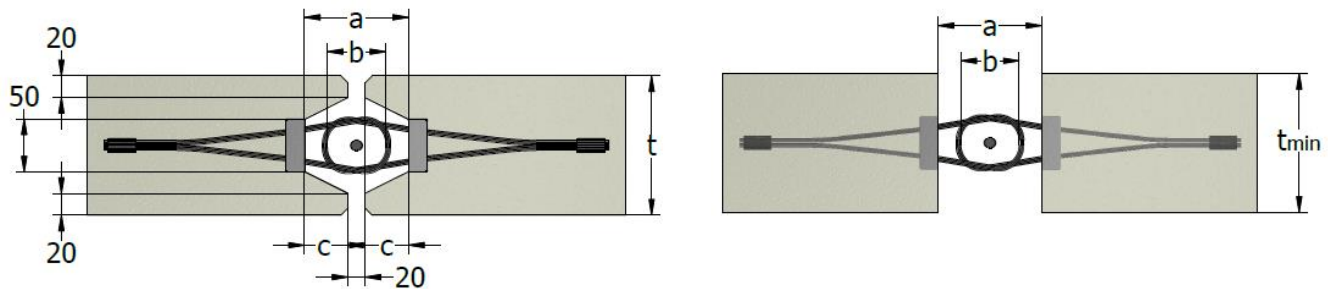

Terwa Loop Box	Total recess dimension <i>a</i>	Overlap <i>b</i>	Recess depth <i>c</i>	Wall thickness <i>t<sub>min</sub></i>
Type	[mm]	[mm]	[mm]	[mm]
<b>TLB-060</b>	80	40	30	80
<b>TLB-080</b>	100	60	40	80
<b>TLB-100</b>	120	80	50	120
<b>TLB-120</b>	140	100	60	120
<b>TLB-140</b>	160	120	70	150

For selecting the the suitable type of Terwa Loop Box, the following aspects must be considered:

- Wall thickness
- Geometry of the joint
- Load-bearing capacity.

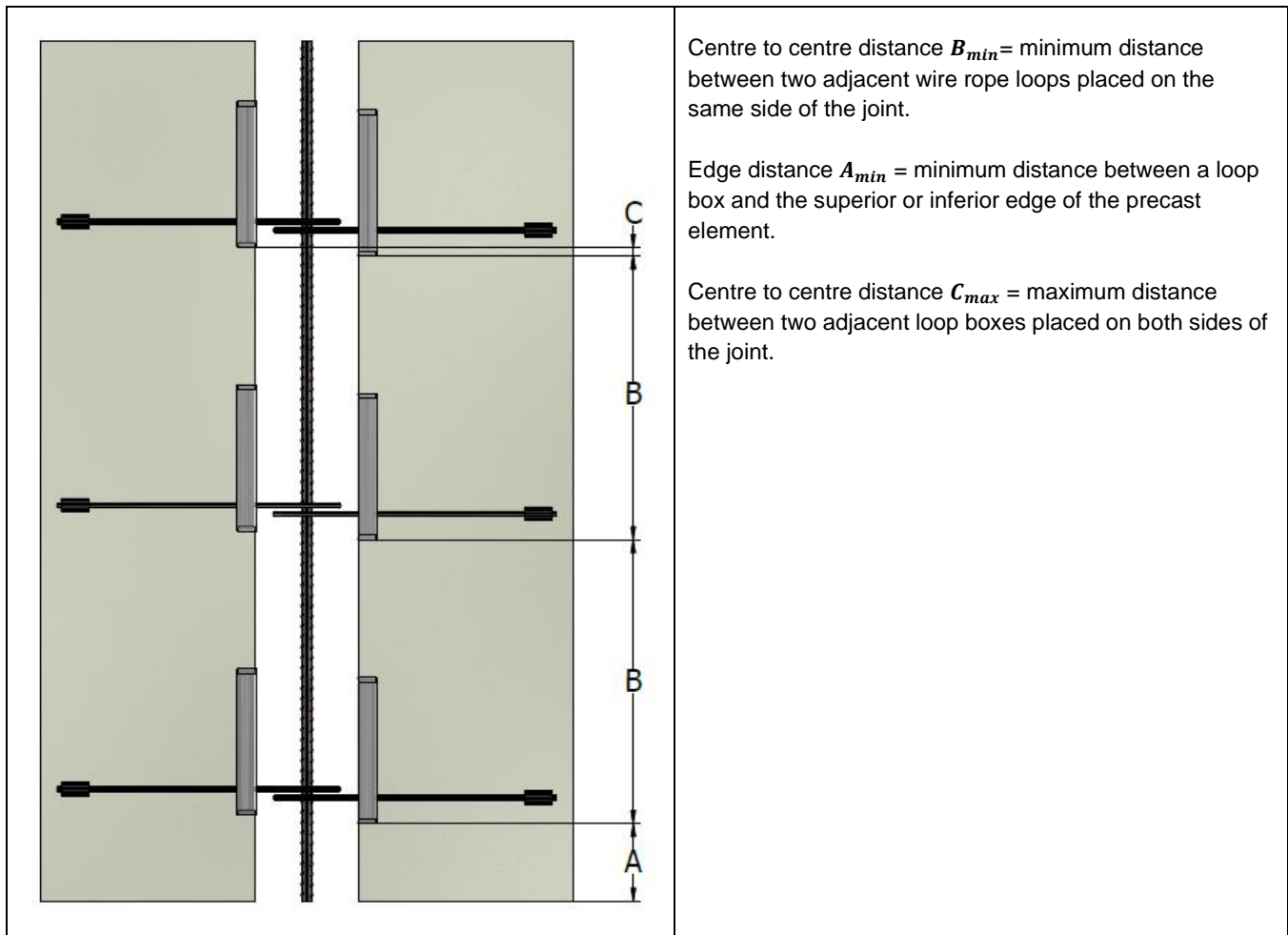
**MINIMUM EDGE DISTANCE AND THE MINIMUM DISTANCE BETWEEN THE CENTRES OF LOOPS**

Minimum distances of the Loop Box TLB

Terwa Loop Box	Centre to centre distance $B_{min}$ [mm]	Edge distances $A_{min}$ [mm]	Centre to centre distance $C_{max}$ [mm]
TLB-060	250	120	20
TLB-080			
TLB-100			
TLB-120			
TLB-140	350	200	

The type of the loop box must be chosen accordingly with the thickness of the joint to allow to a vertical reinforcing bar to pass inside the cable loops in both directions of the joint.

Total width of the concrete wall should be chosen considering getting the desired width, the width of the steel box and minimum thickness of concrete cover layer (20mm).

By arranging several wire ropes loops one on another, the force value that can be transmitted by a TLB cable loop is multiplied by the number of loops used on condition that they do not interact with each other. This is supposed to be valid if the space between two adjacent TLB steel boxes is sufficiently large.

## REINFORCEMENTS

A vertical reinforcement bar made of B500B called lock bar is installed in the centre joint. This bar is designed to take the traction forces that occur in concrete joint.

Recommended dimensions for internal reinforcement

Terwa Loop Box	Diameter of reinforcing bar [mm]
TLB-080	12
TLB-100	
TLB-120	
TLB-140	16

The precast concrete elements must be reinforced in accordance with project requirements. TLB loop boxes provide good anchorage by making a sufficient overlapping of cable loops with precast elements reinforcements. We recommend using U-shaped stirrup installed in the area of each wire loop.

TLB system must be installed so that the loop axes lie symmetrically about the axis cross-section, to ensure that all loops are evenly loaded.

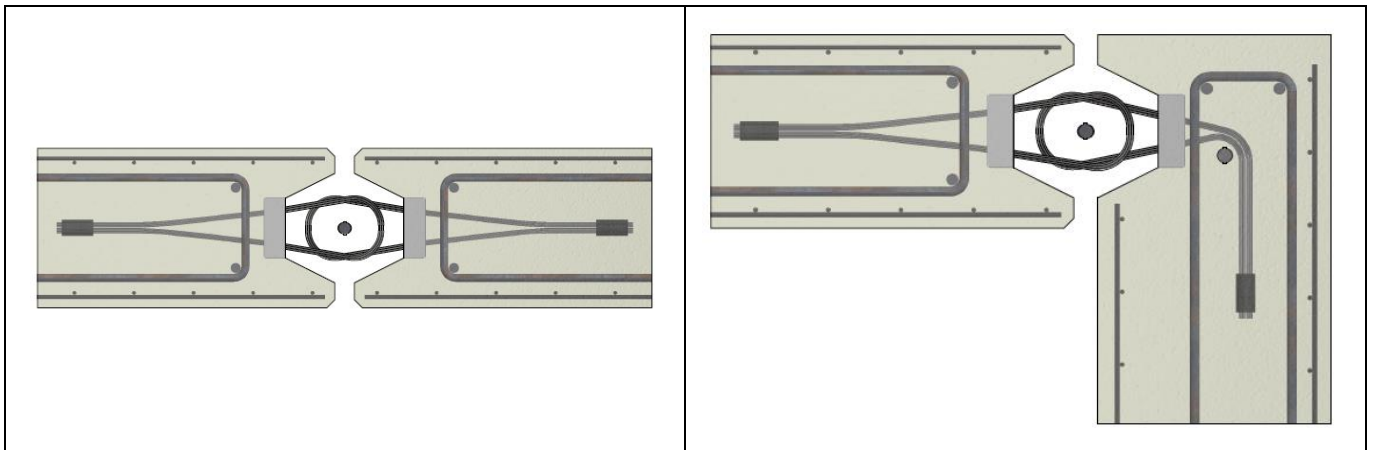

## Resistances

Resistances of joints with the Terwa loop box are defined according to loop spacing and compressive strength of concrete grout in the joint. Resistances are determinate by a design concept that refers to the standards EN 1990-1, EN 1992-1-1 (2004), EN 1992-1-2 (2004).

Resistance of the Terwa loop box joint for combined forces may be calculated according to equation:

$$\frac{V_{Ed}}{V_{Rd}} + \frac{N_{Ed}}{N_{Rd}} + \frac{F_{Ed}}{F_{Rd}} \leq 1$$

Where:

- $V_{Ed}$  – design value of longitudinal shear force
- $V_{Rd}$  – design value of resistance for longitudinal shear force
- $N_{Ed}$  – design value of transverse shear force
- $N_{Rd}$  – design value of resistance for transverse shear force
- $F_{Ed}$  – design value of tensile force
- $F_{Rd}$  – design value of resistance for tensile force



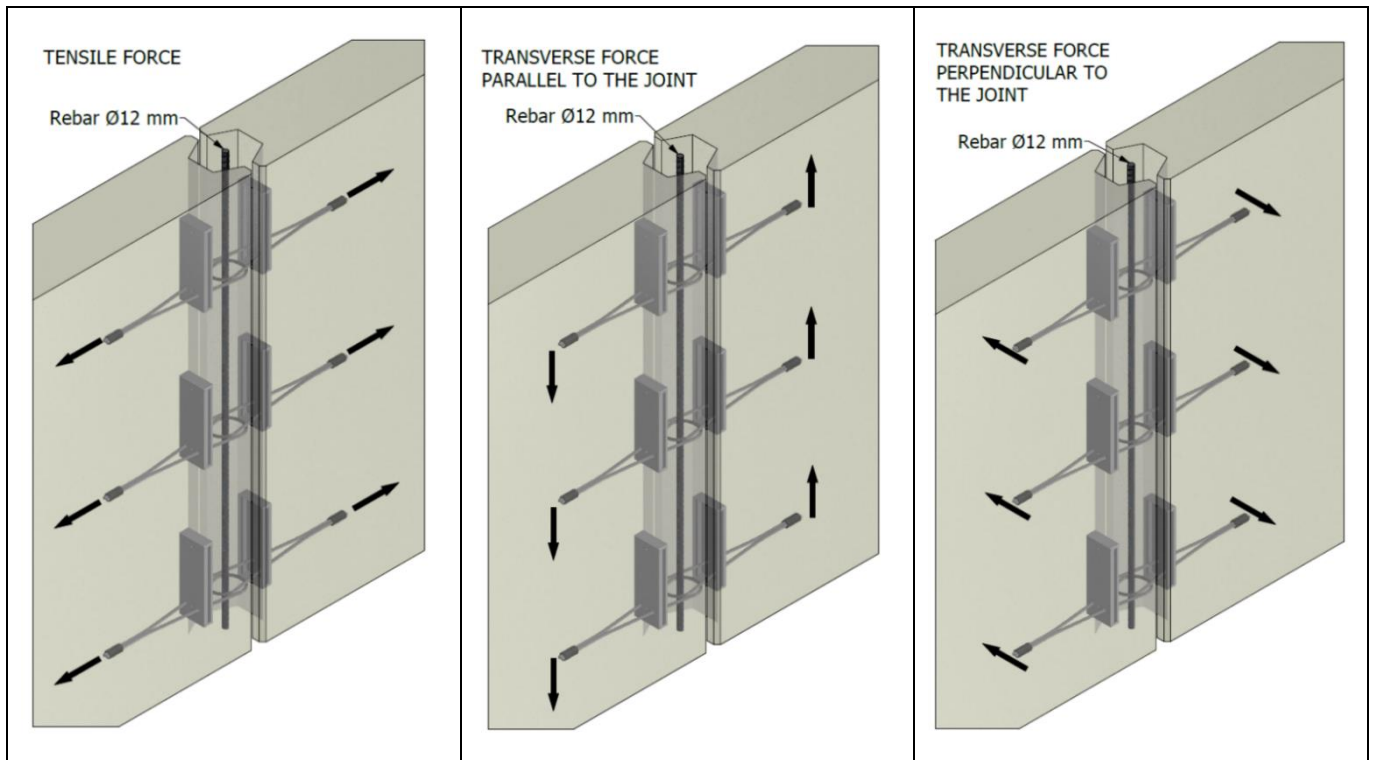
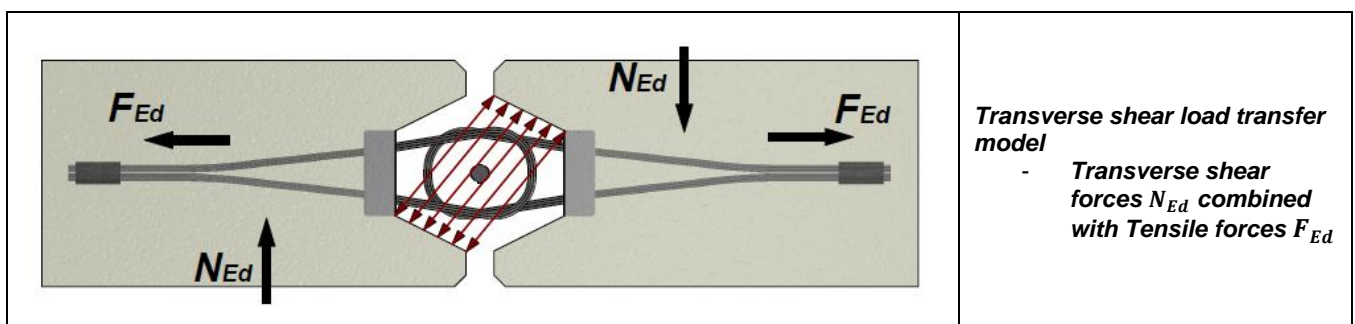
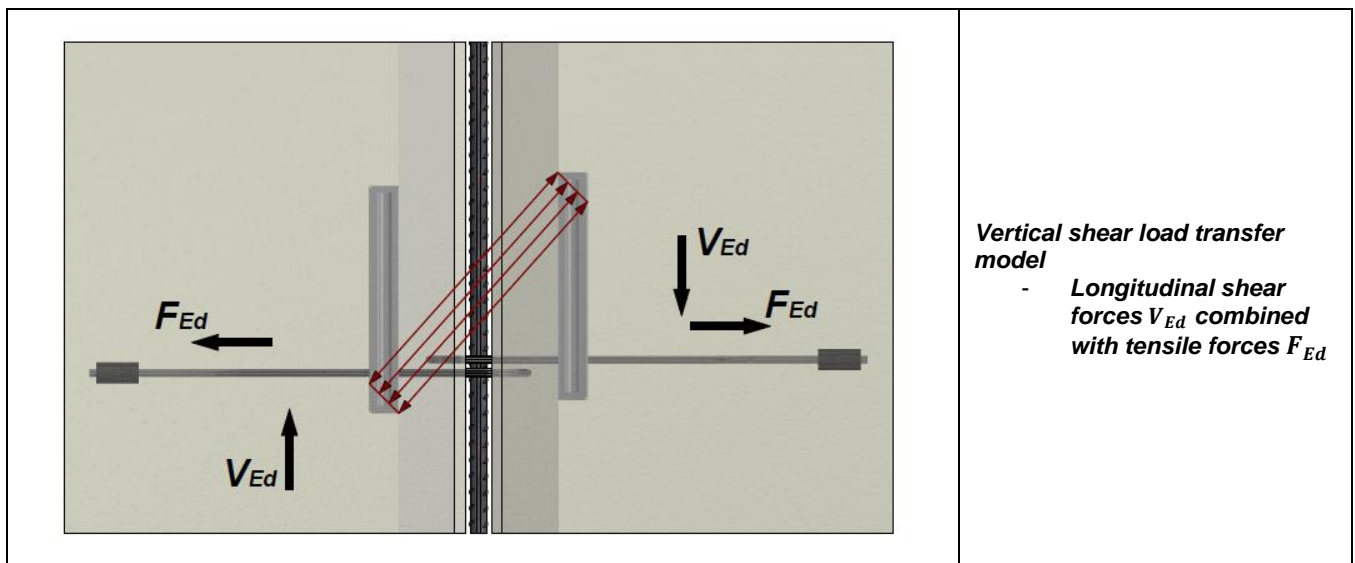

**Calculation model**

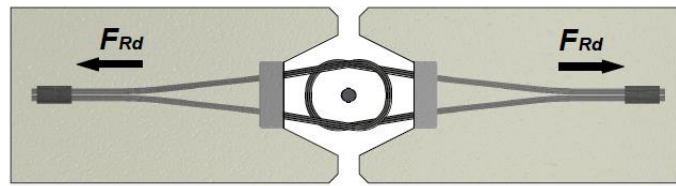
**Important! It is not possible to transfer any bending moments with the Terwa loop box connection.**

**Tensile forces - design value in one pair of wire rope loops**

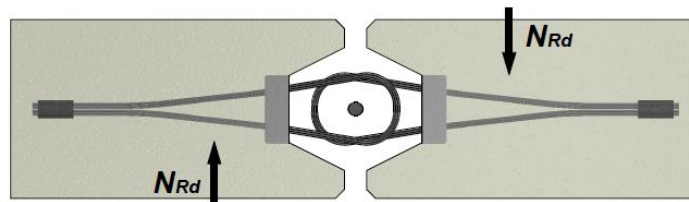
Terwa Loop Box	Tensile resistance $F_{Rd}$ in one pair of wire rope loops [kN/pair of boxes]				
	C25/30	C30/37	C35/45	C40/50	C45/55
TLB-060	11.40	12.63	13.87	15.83	17.10
TLB-080					
TLB-100					
TLB-120					
TLB-140	15.96	17.70	19.41	22.08	23.94

**Transverse shear forces - design value in one pair of loop boxes**

Terwa Loop Box	Transverse shear resistance $N_{Rd}$ in one pair of wire rope loops [kN/pair of boxes]				
	C25/30	C30/37	C35/45	C40/50	C45/55
TLB-060	2.99	3.27	3.55	3.81	4.03
TLB-080					
TLB-100					
TLB-120					
TLB-140	3.70	4.10	4.40	4.80	5.10

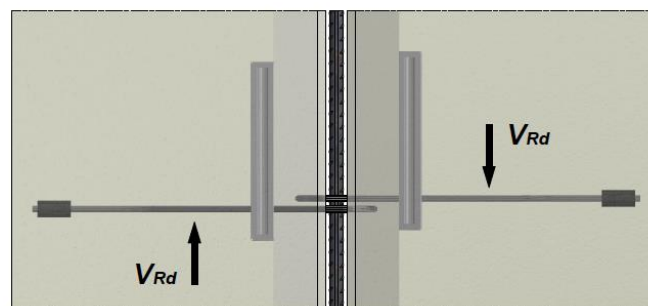
**Longitudinal shear forces - design value in one pair of loop boxes**



Terwa Loop Box	Longitudinal shear resistance $V_{Rd}$ in one pair of wire rope loops [kN/pair of boxes]				
	C25/30	C30/37	C35/45	C40/50	C45/55
TLB-060	14.20	15.75	17.30	19.70	21.40
TLB-080					
TLB-100					
TLB-120					
TLB-140	27.30	30.22	33.20	37.72	40.90

## INSTALLATION INSTRUCTIONS

### FIXING TO FORMWORK

The main steps to follow before casting concrete precast elements:

- The wire loop of the TLB system must be in good condition and no rust or wire breakages.
- Loop box conforms to the technical documentation and placement is correct.
- TLB system is firmly fixed to formwork.
- Additional reinforcements (stirrups) are installed properly.

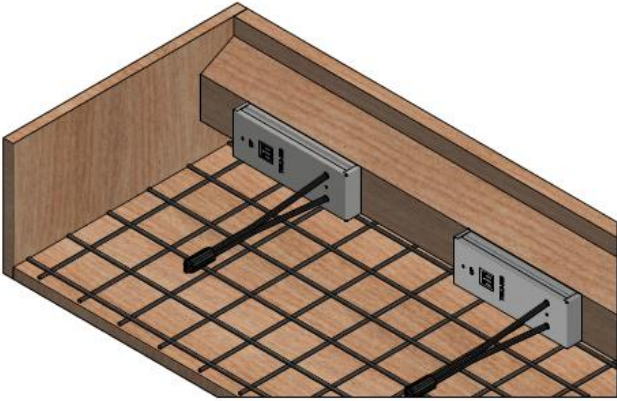
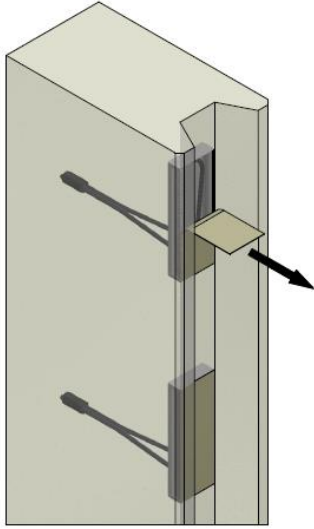
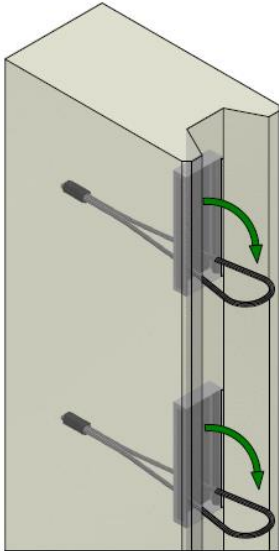
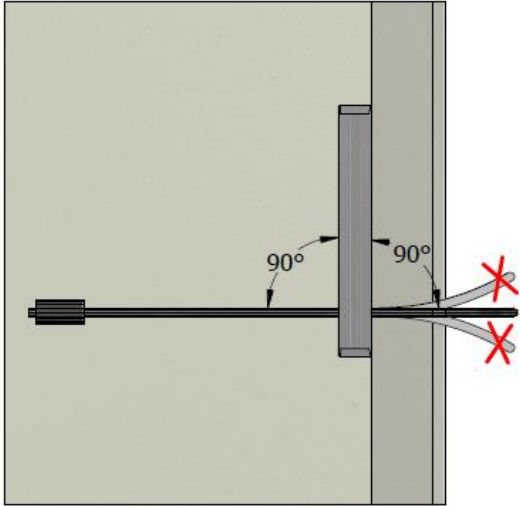
<b>Wire rope damage</b>	
	
<b>Rust</b>	<b>Broken wire</b>
 <p>The boxes must be nailed into place starting from the lowest point of the element. That arrangement must be same on both sides of the joint.</p>	
<b>Fixing the Terwa loop box</b>	<b>Removing the adhesive tape after demoulding</b>
	
<b>Straightening of cable loops</b>	<b>Correct installation of the wire loop perpendicular to wall joint</b>

In the front side of the TLB wire loop box, two or three holes are punched. These are used for fixing with nails on wooden formwork. The sheet box containing the wire loops are closed with strong and flexible tape to prevent entry of concrete when pouring precast wall.

Formwork fixing for the loop box must be firm so that its movement does not appear when pouring concrete. TLB system is fixed to metal or plastic formwork using magnets or adhesives. In this case, the contact surface of the formwork with box flange must be smooth and well degreased before use. Otherwise, they can detach and can move when pouring concrete or during compaction. Concrete near the cable loops should be carefully compacted. Loop boxes must not be vibrated.

The shape of the joint cavity is designed according to the type of application and the type of components used. Mesh reinforcements of the walls should continue to the prominences of the panel edge to avoid breaking of the edges at de-moulding. A slight taper and a good lubrication of the formwork can ease the process of de-moulding.

When fixing the TLB box to the formwork, proper placement of the cable loop must be ensured so that it is as straight as possible between mesh reinforcement.

### CASTING OF PRECAST ELEMENT

The main steps to follow before casting precast elements:

- The TLB cable loop must remain in correct position

### DE-MOULDING

The main steps to follow casting precast elements:

- The position of TLB cable loops is according to design drawings.
- The cover tape of sheet box is removed after hardening of the concrete.

After removing formwork, the flexible cover tape is removed, and the wire rope loop can be easily folded out. Wire rope loops must remain in a plane perpendicular to the front of steel box to ensure a proper and controlled overlap of opposite cable loops. At this moment, the precast concrete element is ready for final assembly on site.

### CASTING JOINT

At final assembly, after placing precast element to the required position, the bar assembly with the diameter shown in upper table is inserted from above to down through all the cable loops. The installed precast wall must always be secured by temporary bracing. To ensure a correct transfer of forces, the joint must be correctly and completely filled with concrete. At the same time, proper compression of the concrete must be ensured. The concrete used in the joint should have a consistency to ensure adequate flow in the intermediate spaces inside steel boxes. We recommended using ready mixed casting kits. If the self-compacting mixtures are used, vibration of concrete is no longer necessary.

### STORAGE REQUIREMENTS

Terwa loop boxes must be stored and protected in dry conditions, under a roof. Large temperature variations, snow, ice, humidity, or saltwater impact may cause damage to wire rope and shorten the service life.

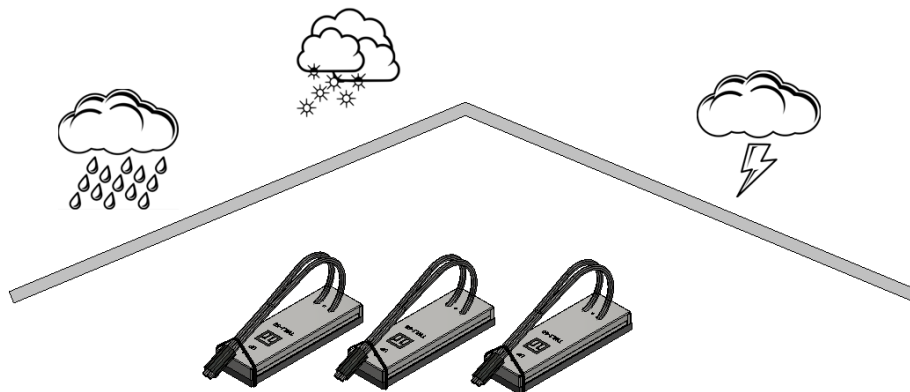

## CONTACT



TERWA is the global supplier for precast and construction solutions with multiple offices around the world. With all our staff, partners and agents, we are happy to provide all construction and precast companies who work in the building industry with full service and 100% support.

### TERWA CONSTRUCTION GROUP

#### Terwa Construction Netherlands (HQ)

**Global Sales & Distribution**  
 Kamerlingh Onneslaan 1-3  
 3401 MZ IJsselstein  
 The Netherlands  
**T** +31-(0)30 699 13 29  
**F** +31-(0)30 220 10 77  
**E** [info@terwa.com](mailto:info@terwa.com)

#### Terwa Construction Central East Europe

**Sales & Distribution**  
 Strada Sânzieni  
 507075 Ghimbav  
 Romania  
**T** +40 372 611 576  
**E** [info@terwa.com](mailto:info@terwa.com)

#### Terwa Construction Poland

**Sales & Distribution**  
 Ul. Cicha 5 lok. 4  
 00-353 Warszawa  
 Poland  
**E** [info@terwa.com](mailto:info@terwa.com)

#### Terwa Construction India & Middle East

**Sales & Distribution**  
 India  
**T** +91 89 687 000 41  
**E** [info@terwa.com](mailto:info@terwa.com)

#### Terwa Construction China

**Sales & distribution**  
 B05, 5F, No. 107, 2nd of the South  
 Zhongshan Road  
 200032 Shanghai  
 China  
**E** [info@terwa.com](mailto:info@terwa.com)

**ALL SPECIFICATIONS CAN BE CHANGED WITHOUT PRIOR NOTICE.**

### DISCLAIMER

Terwa B.V. is not liable for deviations due to wear of the products it has delivered. Neither is Terwa B.V. liable for damage due to inaccurate and/or improper handling and use of the products it has delivered and/or use of same for purposes other than those intended.

Terwa B.V.'s responsibility is furthermore limited in accordance with article 13 of the "Metaalunie" conditions, which are applicable for all Terwa B.V. deliveries. The user is responsible for ensuring compliance with all applicable copyright laws.

Without limiting the rights under copyright,

no part of this documentation may be reproduced, stored in or introduced into a retrieval system, or transmitted in any form or by any means (electronic, mechanical, photocopying, recording, or otherwise), or for any purpose, without the express written permission of Terwa B.V.